

Notice de montage / *Assembly instructions* **BORA BORA**

NE CONVIENT PAS AUX
ENFANTS DE MOINS DE 3 ANS

*Not suitable for children under the age of
three.*

(Présence de pièces pouvant être
ingérées / *small parts can be swallowed*)

DECONSEILLE AUX ENFANTS

DE MOINS DE 7 ANS. / *not
recommended for children under 7.*



Suivre scrupuleusement les indications ci-après. / *Follow the bellowed instructions.*

Matériel nécessaire / necessary tools:

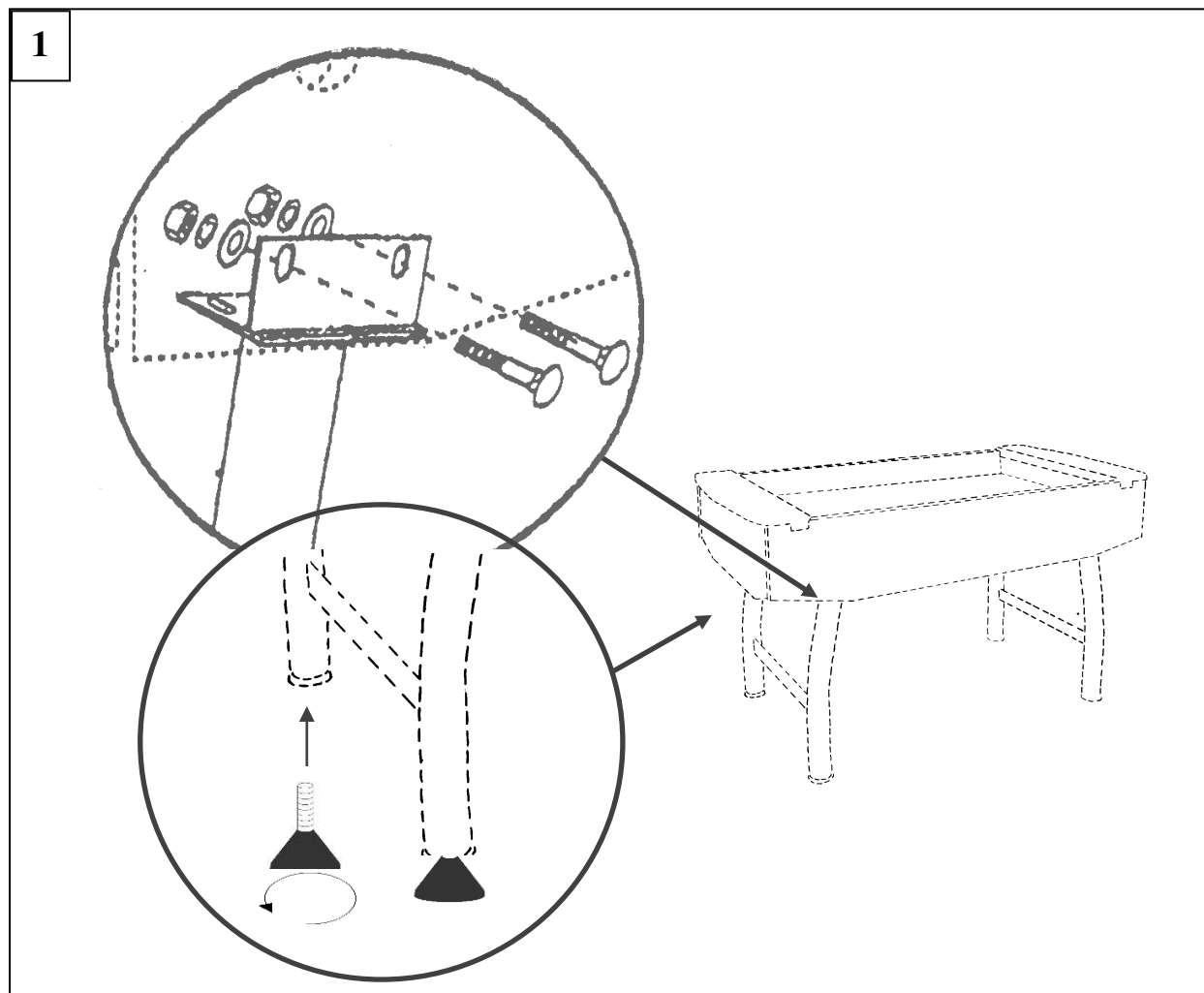
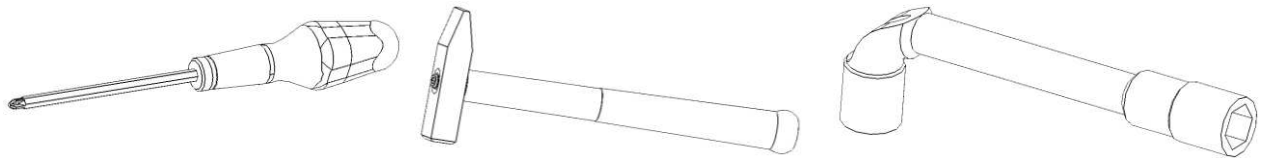

2.1

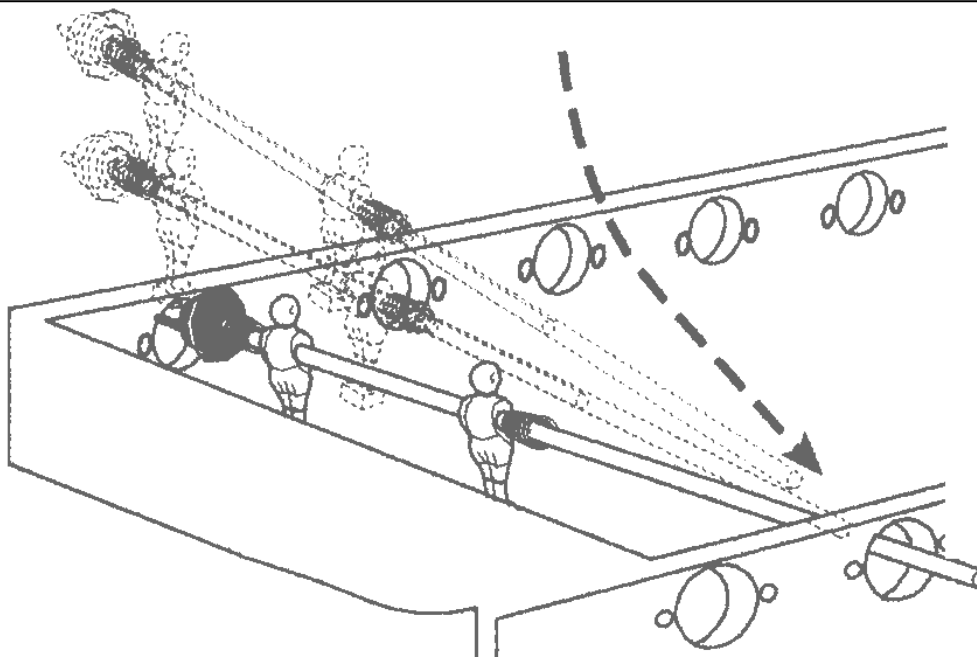

2.2

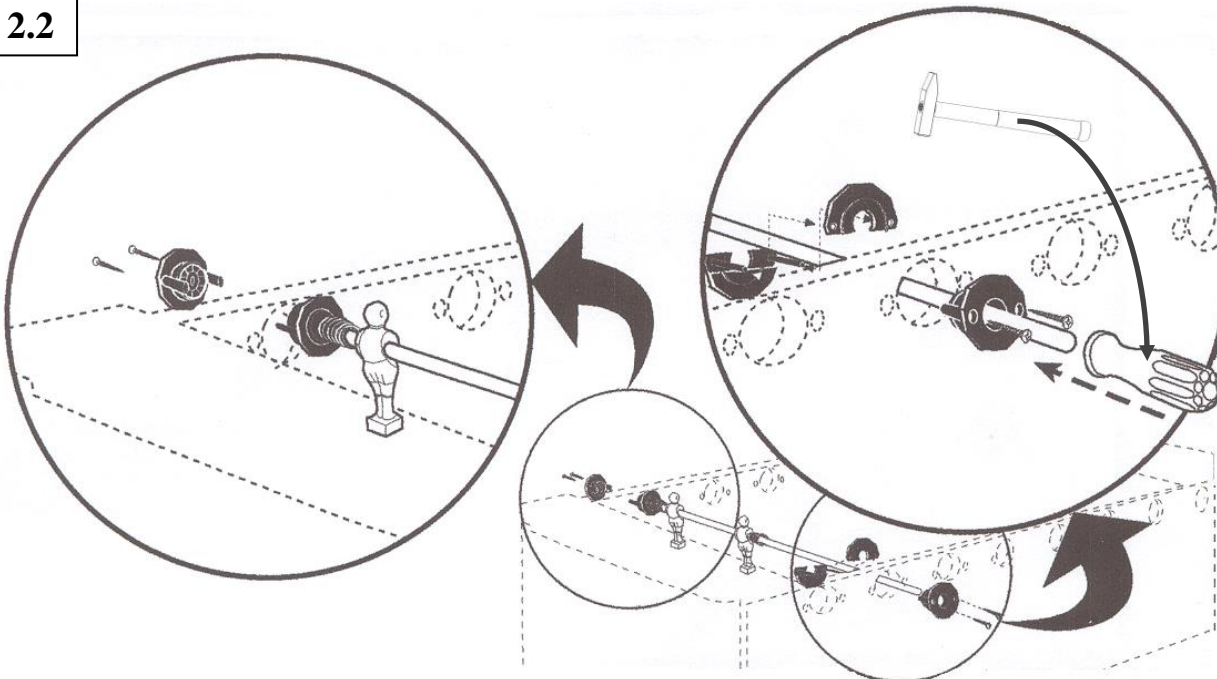

3

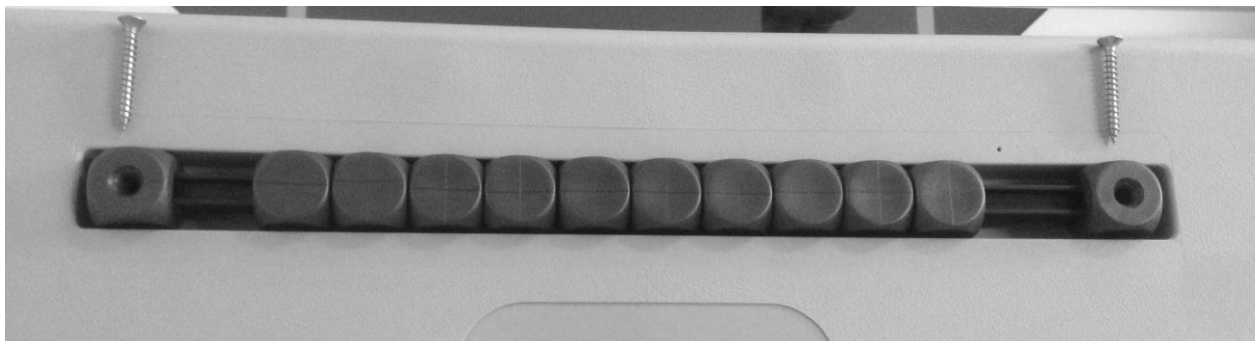
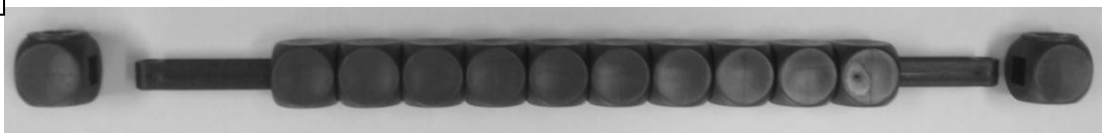

4.1



4.2

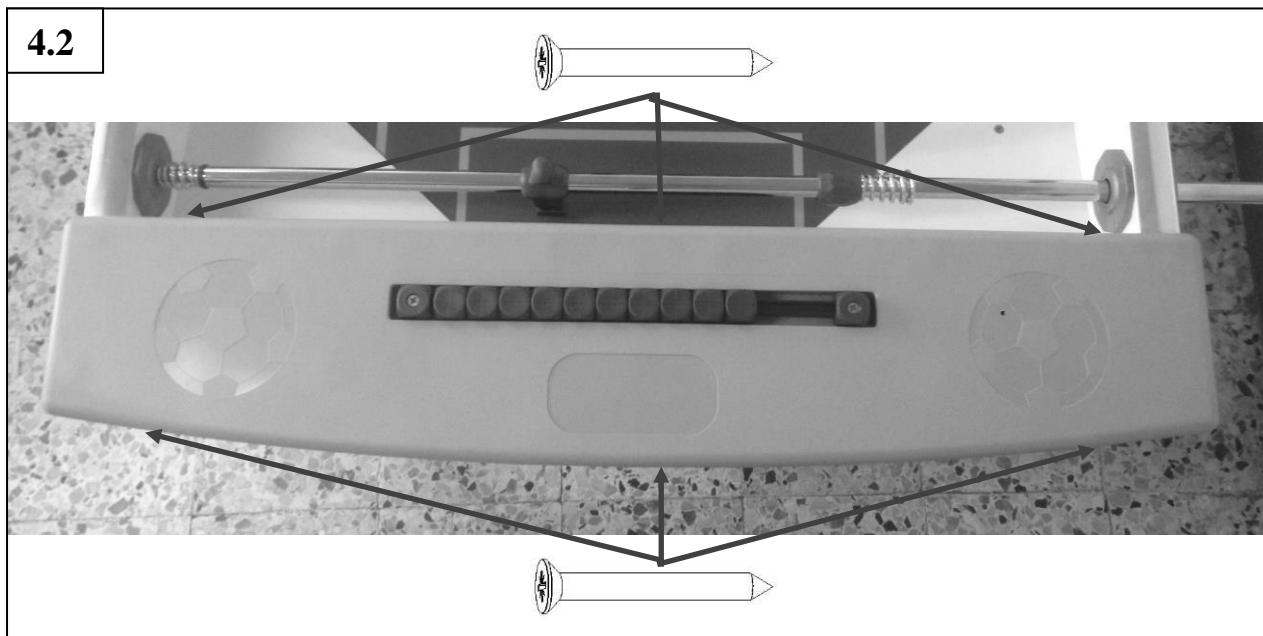

Entretien du baby-foot : Les barres doivent être **impérativement entretenues régulièrement** avec un lubrifiant spécifique. Ce produit est en vente chez René Pierre S.A.

Maintenance: Rods **must be regularly maintained** with a specific lubricant. This product is on sale at René Pierre S.A. You will find the order form in the carton.



Rue du Consier - ZI Crissey - CS 80289

71107 CHALON / SAONE CEDEX FRANCE

Téléphone : 03-85-46-55-45 / E-mail : contact@rene-pierre.fr

Site web : www.rene-pierre.fr